

# 6" STAINLESS STEEL DIGITAL CALIPER

## WARRANTY

### You are backed by the ARES Tool Performance Assurance!

ARES TOOL warrants this product to be free from defects and deficiencies in materials and workmanship under normal use and service. A defective product may be returned for a free replacement within 2 Years from the date of purchase, provided that product is returned immediately after discovery of defect. This warranty shall be valid only when proof of purchase (receipt) showing the date of purchase accompanies the defective product.

### Exclusions:

This warranty excludes blades, bits, bit sockets, carrying cases, pouches, torque products, punches, dies, bulbs, fuses, batteries, and other consumables which must be replaced under normal use and service. This WARRANTY does not cover products which in ARES Tool's judgement have been subject to negligence, misuse, abuse, accident, improper storage, alteration, improper repair, disassembly and/or reassembly. Normal wear and tear are also excluded.

Please call or email at (206) 453-6776 / ares@arestool.com for more details or to receive support.

These warranties set forth herein are the sole warranties applicable to Products and is in lieu of all other warranties, whether expressed, implied or statutory. The implied warranties of merchantability and fitness for a particular purpose are specifically excluded.

Customer's sole and exclusive remedy for breach of this Warranty is, at the option of ARES TOOL, repair or replacement of the defective product.

Please visit us at [WWW.ARESTOOL.COM](http://WWW.ARESTOOL.COM) to register your product and sign up for our ARES Tool Club

G3 MADE IN CHINA  
HECHO EN CHINA  
FABRIQUÉ À CHINA



**WARNING:**  
Cancer and Reproductive Harm-  
[www.p65Warnings.ca.gov](http://www.p65Warnings.ca.gov)



ALWAYS WEAR EYE  
PROTECTION THAT COMPLIES  
WITH ANSI STANDARD

PERFORMANCE ASSURANCE  
**2 YEAR  
Warranty**



# ARES

## 6" STAINLESS STEEL DIGITAL CALIPER

### OPERATIONS MANUAL

### SPECIFICATIONS:

Measurement Range	0.00" – 6.0" (0.0mm – 150mm)
Resolution	0.0005" / 0.01mm
Battery Specification	1x CR2032 3v Coin Battery
Operating Temperature Range	32 – 104°F (0 – 40°C)
Storage Temperature Range	-4 – 158°F (-20 – 70°C)
Screen Size	1.85" x 0.80"

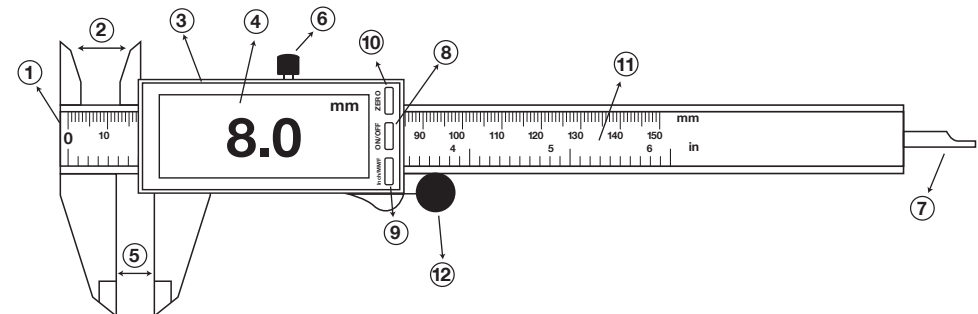

1. Step Measuring Face
2. Internal Jaws
3. Display Housing
4. LCD Display
5. External Measuring Jaws
6. Slider locking knob

7. Depth Measuring Probe
8. Power on/off Button
9. Units Inch / MM / Fraction Button
10. Zero Setting / Rest Button
11. Scale
12. Slider adjustment knob

For Battery removal and replacement flip calipers over LCD screen side facing down to access battery panel.

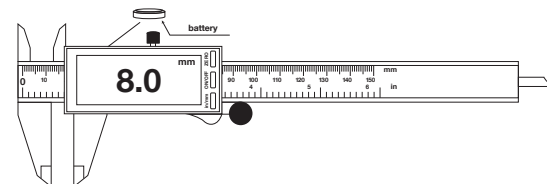

**WARNINGS:**

Follow these safety precautions in order to avoid damage and ensure caliper stays functions optimally.

- DO NOT get calipers wet. Avoid coming in contact with any liquids or excessive humidity.
- DO NOT leave calipers exposed to excessive heat or direct sunlight.
- DO NOT disassemble or tamper with this device.
- DO NOT expose to electromagnetic fields.
- DO NOT ever apply any voltage on any part of the caliper and never use an electric pen or permanent damage may occur.
- Pull out the battery protector before use.

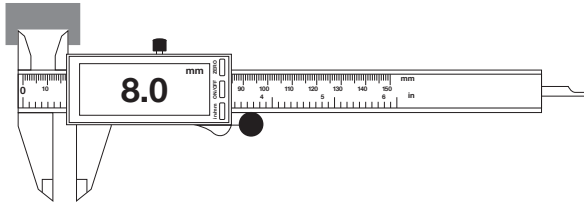
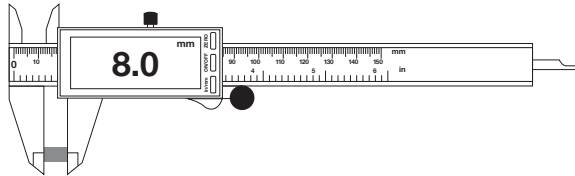
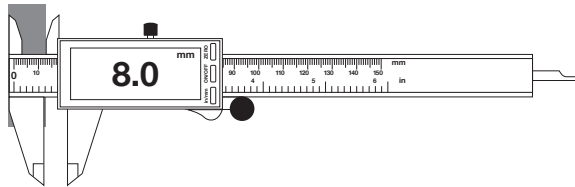
**OPERATION:****1. Inner Distance Measurement****2. Outer Distance Measurement****3. Step Distance Measurement****5. Buttons**

- 'mm/inch' is for metric and inch conversion
- 'ON/OFF' button is to turn on or turn off display
- 'ZERO' is to set the reading on display to be zero.

**6. Zero Out Device before use** - Caliper should be checked before each use to make sure that it is properly zero set. The reading should be zero when the external jaws are closed, otherwise press 'ZERO' to set zero reading. Open and close the external jaws to verify if reading return to zero.

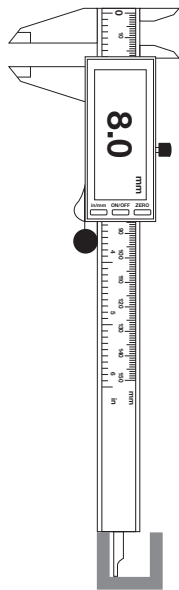
**4. Depth Distance Measurement**

7. Always apply constant force on thumb wheel during measurement and zero setting.

8. Tighten locking screw to hold reading.

**CARE AND MAINTENANCE:**

After each use wipe clean with a soft cloth. DO NOT use any solvents to clean the device. DO NOT immerse in liquid of any kind.

If water damage causes the device to fail. Wipe off the liquid and make sure the are between the slide and scale is completely dry. Rest the caliper by removing the battery for 1 min. Reinstall the battery and turn on the device.

**TROUBLE SHOOTING:**

Problem	Action
Display does not show information	Check battery contact and battery health
Digits are not displaying correctly on screen	Reset the Device – Remove the battery for 1 min then reinstall and restart.
Digits are flashing on screen	Battery is low. Replace Battery

**BATTERY REPLACEMENT & WARNINGS:**

Turn calipers over LCD screen side facing down with the slider lock screw knob facing towards you. Remove the small screw on the same side as the slider lock knob, using caution not to lose the screw. Once screw is removed, the battery cover will be loose and the battery is easily removed. Insert the new battery positive side facing up (+). Replace the cover and tighten the screw.

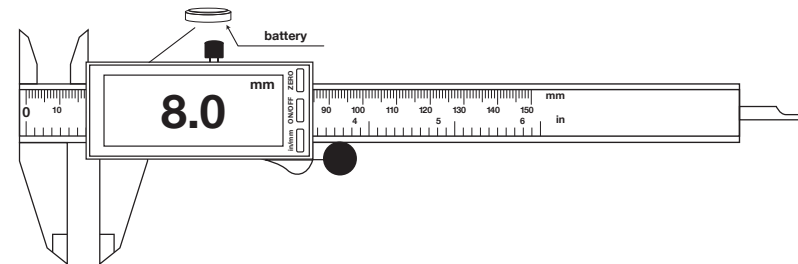

**WARNING: Follow all safety instructions below for handling and disposing of batteries.**

- DO NOT Short circuit batteries.
- DO NOT keep batteries near excessive heat, fire or in direct sunlight.
- Remove batteries from device when not being used for long periods of time.
- NEVER handle leaking batteries and do not dismantle batteries.
- RECYCLE used devices and batteries via local electronics recycling facilities or means.